

Project Name: _____
 Location: _____
 Engineer: _____
 Submitted to: _____
 Submitted by: _____
 Reference: _____

Approval: _____
 Date: _____
 Construction: _____
 Unit #: _____
 Drawing #: _____

Performance

| | |
|--------------------------------|------------------|
| Indoor Unit Model No: | Ducted |
| Outdoor Unit Model No: | RWEYQ144PTJU -HR |
| Cooling Capacity (Btu/hr): | 144000 |
| Sensible Capacity (Btu/hr): | 0 |
| Cooling Input Power (kW): | |
| Cooling EER (Btu/hr / kW): | 15.3 |
| SEER: | N/A |
| Heating Capacity (Btu/hr): | 162000 |
| Heating Input Power (kW): | |
| Heating COP (Btu/hr / Btu/hr): | 5.3 |
| HSPF: | N/A |

| | |
|----------------------------|-------------------------------|
| Indoor Unit Type: | |
| Condensing Unit Type: | 12-Ton VRV-VIII Heat Recovery |
| Cooling Nominal Conditions | Indoor: 80°F DB/67°F WB |
| | Outdoor: 95°F DB/75°F WB |
| | Water Cooled: 85 |
| Heating Nominal Conditions | Indoor: 47°F DB/43°F WB |
| | Outdoor: 47°F DB/43°F WB |
| | Water Cooled: 70 |
| Nominal Piping Length | 25 |
| Nominal Height Separation | 0 |
| Nominal Water Flow Rate | 25.4 GPM |

Indoor Unit Details

| | |
|----------------------------|-----|
| Power Supply (V/Hz/Ph): | N/A |
| Power Supply Connections: | |
| Min. Circuit Amps MCA (A): | |
| Max. Fusible Amps MFA (A): | |
| Dimensions (HxWxD): | N/A |
| Panel (HxWxD): | N/A |
| Net Weight (lbs): | |
| Weight with Panel (lbs): | |

| | |
|--|-----|
| Airflow Rate (CFM wet coil) | N/A |
| Moisture Removal (pt/h): | |
| Gas Pipe Connection (inch): | |
| Liquid Pipe Connection (inch): | |
| Condensate Connection (inch): | |
| Sound Pressure Level (dBA): | |
| Sound Power Level (dBA): | |
| Nominal External Static Pressure (inH2O) | |
| Max Ext Static Pressure (inH2O) | |

Condensing Unit Details

| | |
|-------------------------------|------------------------|
| Power Supply (V/Hz/Ph): | 208-230/60/3ph |
| Power Supply Connections: | L1, L2, L3 Ground |
| Min. Circuit Amps MCA (A): | 22.4+22.4 |
| Max. Fusible Amps MFA (A): | 40 + 40 |
| Max. Starting Current MSC(A): | - |
| Rated Load Amps RLA (A): | 11.6+11.6 |
| Total Overcurrent Amps (A): | 24 + 24 |
| Dimensions (HxWxD): | 39-3/8x62-1/4x21-11/16 |
| Net Weight (lbs): | 330 x 2 |
| Compressor Type: | Inverter |
| Capacity Control Range (%): | 11 - 100 |
| Capacity Index Limit: | 72 - 187 (130%) |

| | |
|-------------------------------------|-------------|
| Airflow Rate (CFM): | N/A |
| Gas Pipe Connection (inch): | 1-1/8 |
| Liquid Pipe Connection (inch): | 1/2 |
| H/L Pressure Connection (inch): | 7/8 |
| H/L Equalizing Connection (inch): | |
| Water Inlet Connection (inch FPT): | 1-1/4FPT |
| Water Outlet Connection (inch FPT): | 1-1/4FPT |
| Condensate Drain Outlet (inch FPS): | 1/2FPS |
| Sound Pressure Level (dBA): | 53 |
| Sound Power Level (dBA): | |
| Unit Heat Rejection (kW): | 0.64 + 0.64 |
| Max. No. of Indoor Units: | 20 |

System Details

| | |
|-----------------------------------|-----------------|
| Refrigerant Type: | R-410A |
| Holding Refrigerant Charge (lbs): | 9.9+9.9 |
| Additional Charge (oz/ft): | install data |
| Pre-charge Piping (Length ft): | - |
| Max. Pipe Length (Total ft): | 390 ft |
| Max. Pipe Length (Vertical ft): | 164 ft / 130 ft |

| | |
|--------------------------------|-----------------------|
| Cooling Operation Range (°F): | 35 - 104 (Mech. Room) |
| Cooling Range w/Baffle (°F): | |
| Heating Operation Range (°F): | 35 - 104 (Mech. Room) |
| Heating Range w/Baffle (°F): | |
| Cooling Inlet Water Temp (°F): | (43) 59 - 113 |
| Heating Inlet Water Temp (°F): | (14) 50 - 113 |
| Water Flow Range (GPM): | 13.2 - 39.5 |



Submittal Data Sheet

Project Name: _____

Location: _____

Engineer: _____

Submitted to: _____

Submitted by: _____

Reference: _____

Approval: _____

Date: _____

Construction: _____

Unit #: _____

Drawing #: _____

Project Name: _____
 Location: _____
 Engineer: _____
 Submitted to: _____
 Submitted by: _____
 Reference: _____

Approval: _____
 Date: _____
 Construction: _____
 Unit #: _____
 Drawing #: _____

Dimensional Drawing - Condensing Unit

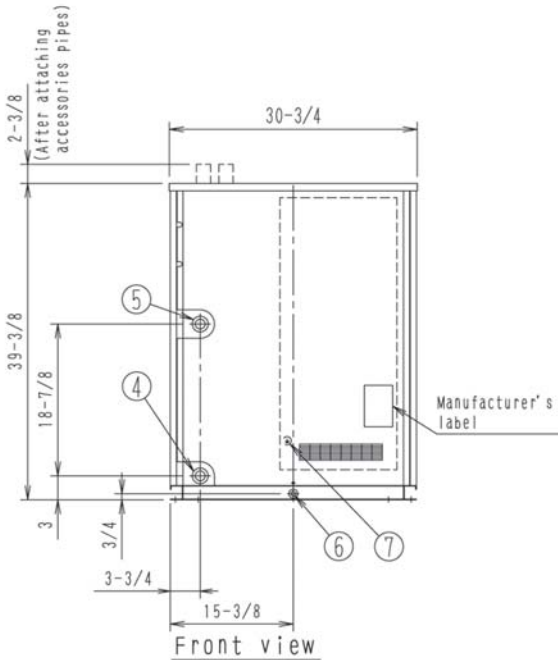
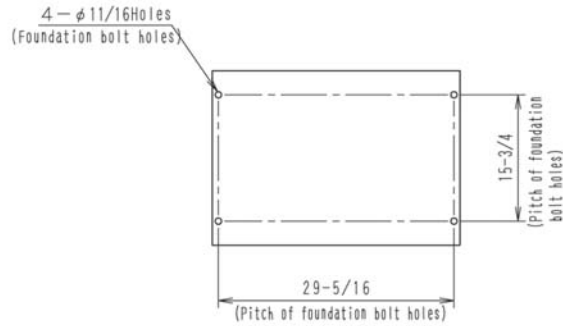
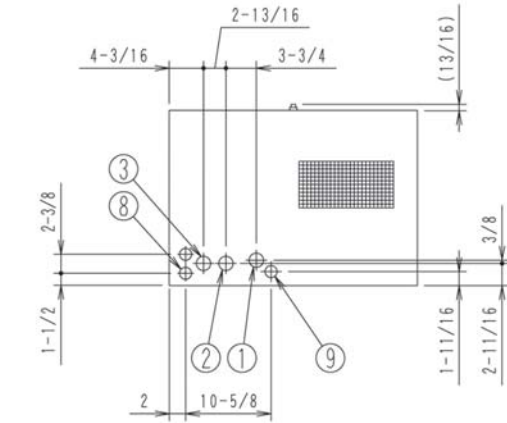

Right side view



Rear view

Project Name: _____
Location: _____
Engineer: _____
Submitted to: _____
Submitted by: _____
Reference: _____

Approval: _____
Date: _____
Construction: _____
Unit #: _____
Drawing #: _____

Notes

Requires Multi Connection Pipe Kit (BHFP26MA56U), Std U.S. Warranty: 6yrs Compressor, 1yrs Parts, 1yr Limited Labor